

# Hyper TOPLED Hyper-Bright LED

LB T673, LV T673, LT T673



## Besondere Merkmale

- **Gehäusetyp:** weißes P-LCC-2 Gehäuse
- **Besonderheit des Bauteils:** extrem breite Abstrahlcharakteristik; ideal für Hinterleuchtungen und Einkopplungen in Lichtleiter
- **Wellenlänge:** 470 nm (blau), 505 nm (verde), 528 nm (true green)
- **Abstrahlwinkel:** Lambertischer Strahler (120°)
- **Technologie:** InGaN
- **optischer Wirkungsgrad:** 2 lm/W (blau), 6 lm/W (verde), 8 lm/W (true green)
- **Gruppierungsparameter:** Lichtstärke, Wellenlänge
- **Verarbeitungsmethode:** für alle SMT-Bestücktechniken geeignet
- **Lötmethode:** IR Reflow Löten und Wellenlöten (TTW)
- **Vorbehandlung:** nach JEDEC Level 2
- **Gurtung:** 8 mm Gurt mit 2000/Rolle,  $\varnothing$ 180 mm oder 8000/Rolle,  $\varnothing$ 330 mm
- **ESD-Festigkeit:** ESD-sicher bis 2 kV nach EOS/ESD-5.1-1993

## Anwendungen

- Ampelanwendung
- Informationsanzeigen im Außenbereich
- optischer Indikator
- Hinterleuchtung (LCD, Schalter, Tasten, Displays, Werbebeleuchtung, Allgemeinbeleuchtung)
- Innenbeleuchtung im Automobilbereich (z.B. Instrumentenbeleuchtung, u. ä.)
- Markierungsbeleuchtung (z.B. Stufen, Fluchtwege, u.ä.)
- Signal- und Symbolleuchten
- Scanner

## Features

- **package:** white P-LCC-2 package
- **feature of the device:** extremely wide viewing angle; ideal for backlighting and coupling in light guides
- **wavelength:** 470 nm (blue), 505 nm (verde), 528 nm (true green)
- **viewing angle:** Lambertian Emitter (120°)
- **technology:** InGaN
- **optical efficiency:** 2 lm/W (blue), 6 lm/W (verde), 8 lm/W (true green)
- **grouping parameter:** luminous intensity, wavelength
- **assembly methods:** suitable for all SMT assembly methods
- **soldering methods:** IR reflow soldering and TTW soldering
- **preconditioning:** acc. to JEDEC Level 2
- **taping:** 8 mm tape with 2000/reel,  $\varnothing$ 180 mm or 8000/reel,  $\varnothing$ 330 mm
- **ESD-withstand voltage:** up to 2 kV acc. to EOS/ESD-5.1-1993

## Applications

- traffic lights
- outdoor displays
- optical indicators
- backlighting (LCD, switches, keys, displays, illuminated advertising, general lighting)
- interior automotive lighting (e.g. dashboard backlighting, etc.)
- marker lights (e.g. steps, exit ways, etc.)
- signal and symbol luminaire
- scanners

Typ	Emissions- farbe	Farbe der Lichtaustritts- fläche	Lichtstärke	Lichtstrom	Bestellnummer
Type	Color of Emission	Color of the Light Emitting Area	Luminous Intensity $I_F = 20 \text{ mA}$ $I_V \text{ (mcd)}$	Luminous Flux $I_F = 20 \text{ mA}$ $\Phi_V \text{ (lm)}$	Ordering Code
LB T673-M2N2-1	blue	colorless clear	22.4 ... 45.0	100 (typ.)	Q62703-Q4838
LB T673-N2Q1-1			35.5 ... 90.0	180 (typ.)	Q62703-Q4887
LV T673-Q1R1-1	verde	colorless clear	71.0 ... 140.0	310 (typ.)	Q62703-Q4845
LV T673-R1S2-1			112.0 ... 280.0	560 (typ.)	Q62703-Q4891
LT T673-Q2R2-1	true green	colorless clear	90.0 ... 180.0	390 (typ.)	Q62703-Q4851
LT T673-R2T1-1			140.0 ... 355.0	700 (typ.)	Q62703-Q4895

Anm.: -1 gesamter Farbbereich, Lieferung in Einzelgruppen (siehe **Seite 5**)

*Die Standardlieferform von Serientypen beinhaltet eine untere bzw. eine obere Familiengruppe, die aus nur 3 bzw. 4 Halbgruppen besteht. Einzelne Halbgruppen sind nicht erhältlich.  
In einer Verpackungseinheit / Gurt ist immer nur eine Halbgruppe enthalten.*

Note: -1 Total color tolerance range, delivery in single groups (please see **page 5**)

*The standard shipping format for serial types includes a lower or upper family group of 3 or 4 individual groups. Individual half groups are not available.  
No packing unit / tape ever contains more than one luminous intensity half group.*

**Grenzwerte  
Maximum Ratings**

Bezeichnung Parameter	Symbol Symbol	Werte Values		Einheit Unit
		LB	LV, LT	
Betriebstemperatur Operating temperature range	$T_{op}$	- 40 ... + 100		°C
Lagertemperatur Storage temperature range	$T_{stg}$	- 40 ... + 100		°C
Sperrschichttemperatur Junction temperature	$T_j$	+ 110	+ 125	°C
Durchlassstrom Forward current	$I_F$	20		mA
Stoßstrom Surge current $t \leq 10 \mu s, D = 0.005$	$I_{FM}$	200	250	mA
Sperrspannung Reverse voltage	$V_R$	5		V
Leistungsaufnahme Power consumption $T_A \leq 25 \text{ °C}$	$P_{tot}$	85		mW
Wärmewiderstand Thermal resistance Sperrschicht/Umgebung Junction/ambient	$R_{th JA}$	400		K/W
Sperrschicht/Löt看 Junction/solder point Montage auf PC-Board FR 4 (Padgröße $\geq 16 \text{ mm}^2$ ) mounted on PC board FR 4 (pad size $\geq 16 \text{ mm}^2$ )	$R_{th JS}$	180		K/W

**Kennwerte** ( $T_A = 25\text{ °C}$ )

**Characteristics**

Bezeichnung Parameter	Symbol Symbol	Werte Values			Einheit Unit
		LB	LV	LT	
Wellenlänge des emittierten Lichtes Wavelength at peak emission $I_F = 20\text{ mA}$	(typ.) $\lambda_{\text{peak}}$	465	503	523	nm
Dominantwellenlänge <sup>1)</sup> Dominant wavelength $I_F = 20\text{ mA}$	(typ.) $\lambda_{\text{dom}}$	470 $\pm 6$	505 $\pm 7$	528 $\pm 9$	nm
Spektrale Bandbreite bei 50 % $I_{\text{rel max}}$ Spectral bandwidth at 50 % $I_{\text{rel max}}$ $I_F = 20\text{ mA}$	(typ.) $\Delta\lambda$	25	30	33	nm
Abstrahlwinkel bei 50 % $I_V$ (Vollwinkel) Viewing angle at 50 % $I_V$	(typ.) $2\phi$	120	120	120	Grad deg.
Durchlassspannung <sup>2)</sup> Forward voltage $I_F = 20\text{ mA}$	(typ.) $V_F$ (max.) $V_F$	3.5 4.1	3.3 4.1	3.3 4.1	V V
Sperrstrom Reverse current $V_R = 5\text{ V}$	(typ.) $I_R$ (max.) $I_R$	0.01 10	0.01 10	0.01 10	$\mu\text{A}$ $\mu\text{A}$
Temperaturkoeffizient von $\lambda_{\text{peak}}$ Temperature coefficient of $\lambda_{\text{peak}}$ $I_F = 20\text{ mA}; -10\text{ °C} \leq T \leq 100\text{ °C}$	(typ.) $TC_{\lambda_{\text{peak}}}$	0.04	0.03	0.04	nm/K
Temperaturkoeffizient von $\lambda_{\text{dom}}$ Temperature coefficient of $\lambda_{\text{dom}}$ $I_F = 20\text{ mA}; -10\text{ °C} \leq T \leq 100\text{ °C}$	(typ.) $TC_{\lambda_{\text{dom}}}$	0.02	0.02	0.03	nm/K
Temperaturkoeffizient von $V_F$ Temperature coefficient of $V_F$ $I_F = 20\text{ mA}; -10\text{ °C} \leq T \leq 100\text{ °C}$	(typ.) $TC_V$	- 2.9	- 3.2	- 3.6	mV/K
Optischer Wirkungsgrad Optical efficiency $I_F = 20\text{ mA}$	(typ.) $\eta_{\text{opt}}$	2	6	8	lm/W

<sup>1)</sup> Wellenlängengruppen werden mit einer Stromeinprägedauer von 25 ms und einer Genauigkeit von  $\pm 1\text{ nm}$  ermittelt.  
Wavelength groups are tested at a current pulse duration of 25 ms and a tolerance of  $\pm 1\text{ nm}$ .

<sup>2)</sup> Spannungswerte werden mit einer Stromeinprägedauer von 1 ms und einer Genauigkeit von  $\pm 0.1\text{ V}$  ermittelt.  
Voltages are tested at a current pulse duration of 1 ms and a tolerance of  $\pm 0.1\text{ V}$ .

1) Wellenlängengruppen / Wavelength groups

Gruppe Group	blue		verde		true green		Einheit Unit
	min.	max.	min.	max.	min.	max.	
3	464	468	498	503	519	525	nm
4	468	472	503	507	525	531	nm
5	472	476	507	512	531	537	nm

Helligkeits-Gruppierungsschema

Luminous Intensity Groups

Lichtgruppe Luminous Intensity Group	Lichtstärke Luminous Intensity $I_V$ (mcd)	Lichtstrom Luminous Flux $\Phi_V$ (mlm)
M2	22.4 ... 28.0	75 (typ.)
N1	28.0 ... 35.5	95 (typ.)
N2	35.5 ... 45.0	120 (typ.)
P1	45.0 ... 56.0	150 (typ.)
P2	56.0 ... 71.0	190 (typ.)
Q1	71.0 ... 90.0	240 (typ.)
Q2	90.0 ... 112.0	300 (typ.)
R1	112.0 ... 140.0	380 (typ.)
R2	140.0 ... 180.0	480 (typ.)
S1	180.0 ... 224.0	600 (typ.)
S2	224.0 ... 280.0	760 (typ.)
T1	280.0 ... 355.0	950 (typ.)

Helligkeitswerte werden mit einer Stromeinprägedauer von 25 ms und einer Genauigkeit von  $\pm 11\%$  ermittelt.  
Luminous intensity is tested at a current pulse duration of 25 ms and a tolerance of  $\pm 11\%$ .

Gruppenbezeichnung auf Etikett

Group Name on Label

Beispiel: S2-3

Example: S2-3

Lichtgruppe Luminous Intensity Group	Halbgruppe Half Group	Wellenlänge Wavelength
S	2	3

Relative spektrale Emission  $I_{rel} = f(\lambda)$ ,  $T_A = 25\text{ }^\circ\text{C}$ ,  $I_F = 20\text{ mA}$

Relative Spectral Emission

$V(\lambda)$  = spektrale Augenempfindlichkeit

Standard eye response curve

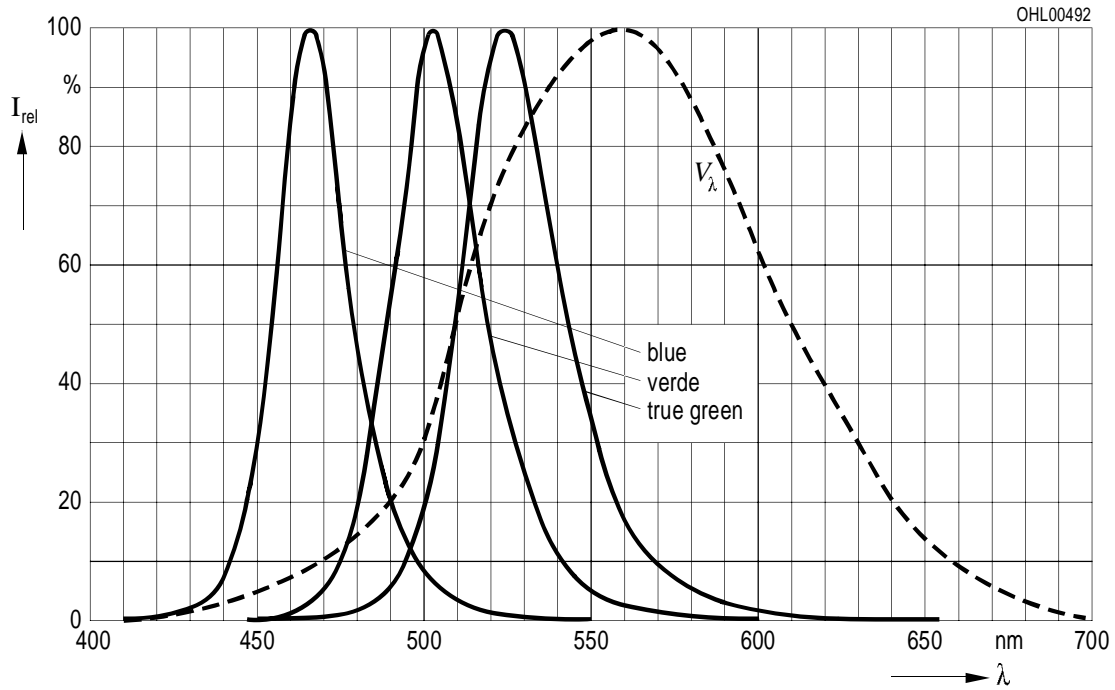

Abstrahlcharakteristik  $I_{rel} = f(\varphi)$

Radiation Characteristic

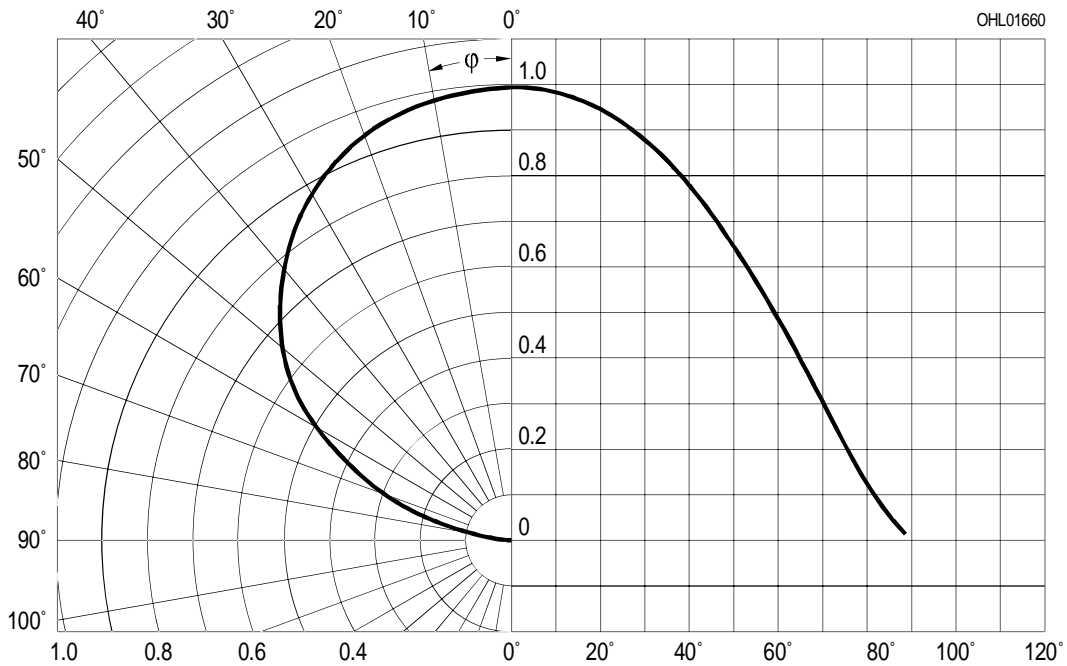

**Durchlassstrom  $I_F = f(V_F)$**

**Forward Current**

$T_A = 25\text{ °C}$

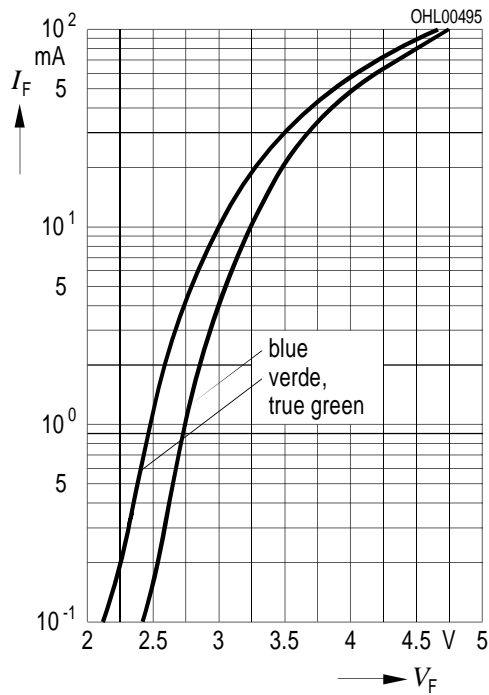

**Relative Lichtstärke  $I_V/I_{V(20\text{ mA})} = f(I_F)$**

**Relative Luminous Intensity**

$T_A = 25\text{ °C}$

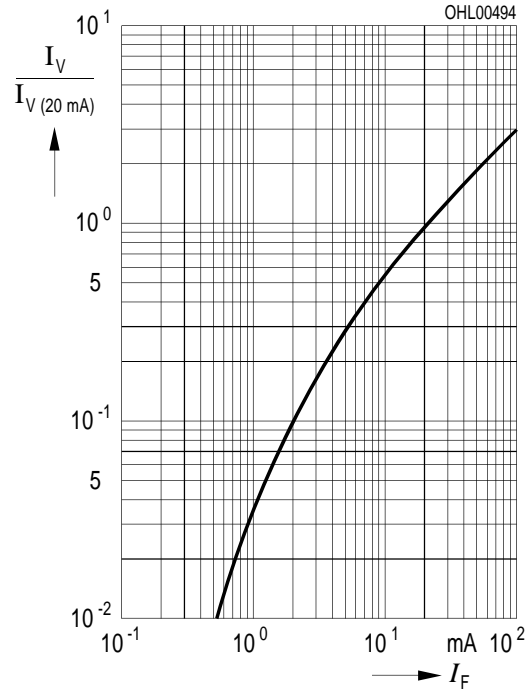

**Maximal zulässiger Durchlassstrom  $I_F = f(T)$**

**Max. Permissible Forward Current**

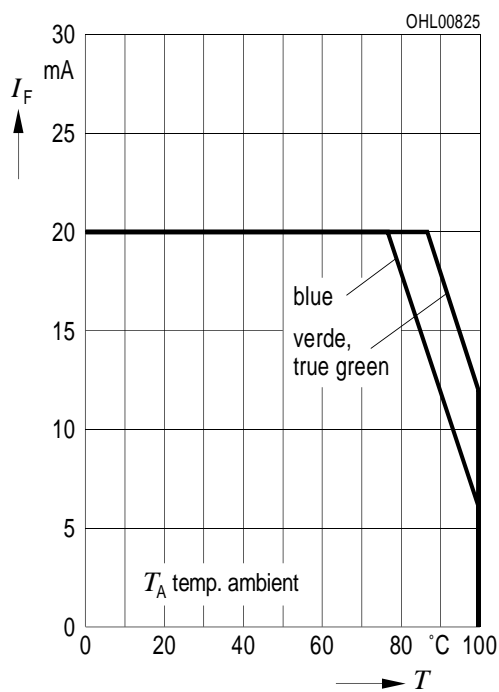

**Maximal zulässiger Durchlassstrom  $I_F = f(T)$**

**Max. Permissible Forward Current**

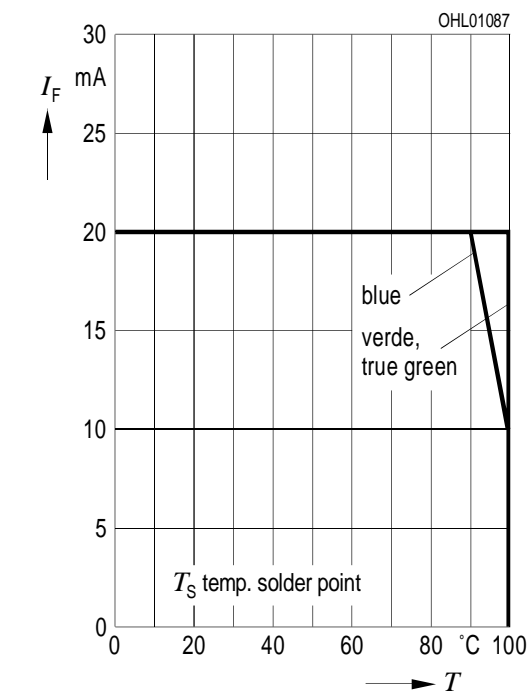

Relative Lichtstärke  $I_V/I_{V(25\text{ }^\circ\text{C})} = f(T_A)$   
 Relative Luminous Intensity

$I_F = 20\text{ mA}$

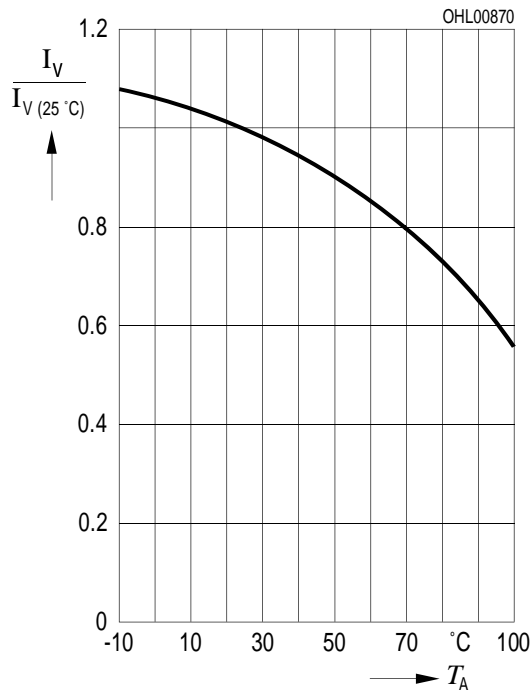

Dominante Wellenlänge  $\lambda_{\text{dom}} = f(I_F)$   
 Dominant Wavelength

LB,  $T_A = 25\text{ }^\circ\text{C}$

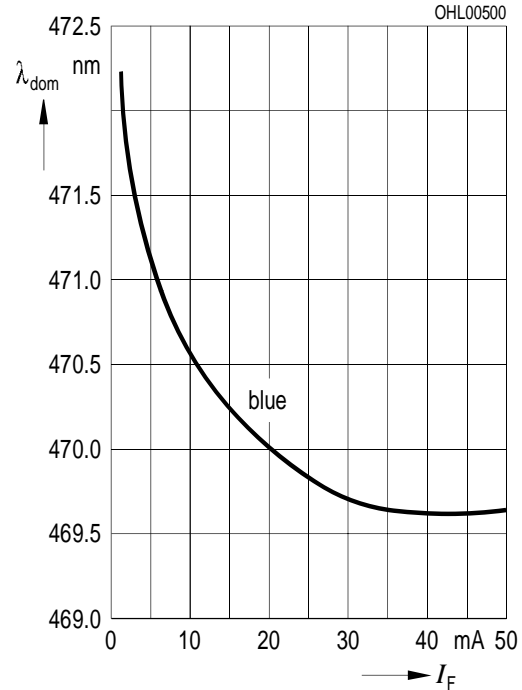

Dominante Wellenlänge  $\lambda_{\text{dom}} = f(I_F)$   
 Dominant Wavelength

LV,  $T_A = 25\text{ }^\circ\text{C}$

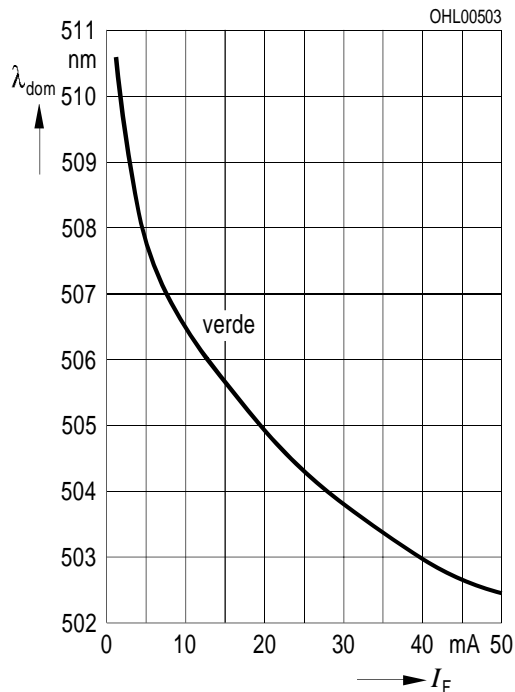

Dominante Wellenlänge  $\lambda_{\text{dom}} = f(I_F)$   
 Dominant Wavelength

LT,  $T_A = 25\text{ }^\circ\text{C}$

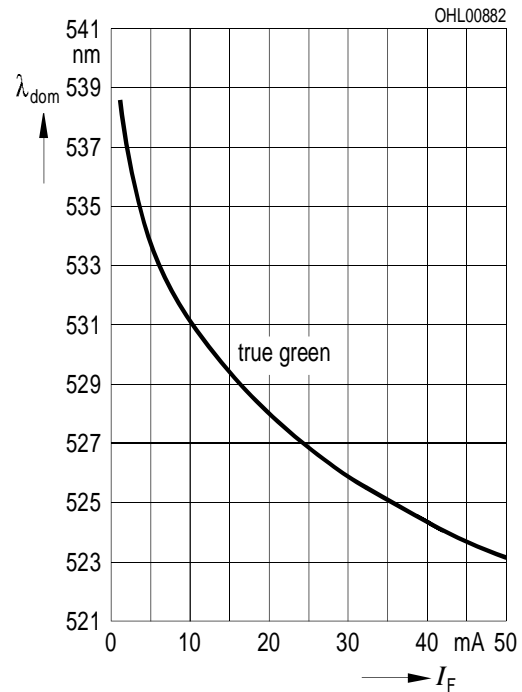



**Zulässige Impulsbelastbarkeit  $I_F = f(t_p)$**   
**Permissible Pulse Handling Capability**  
 Duty cycle  $D = \text{parameter}$ ,  $T_A = 25\text{ °C}$

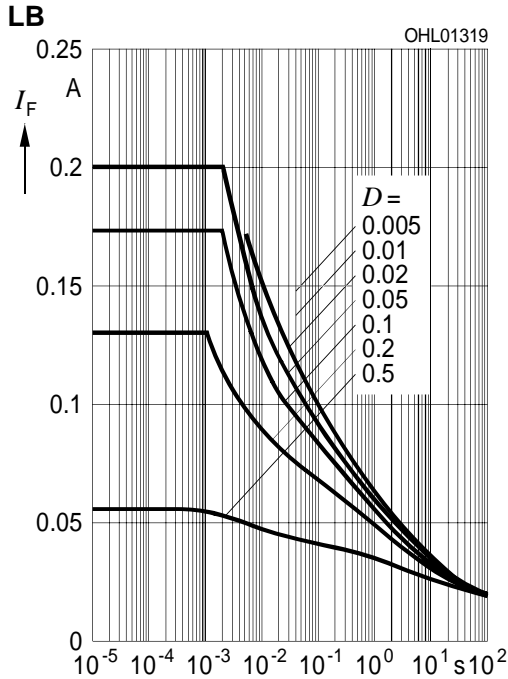

**Zulässige Impulsbelastbarkeit  $I_F = f(t_p)$**   
**Permissible Pulse Handling Capability**  
 Duty cycle  $D = \text{parameter}$ ,  $T_A = 85\text{ °C}$

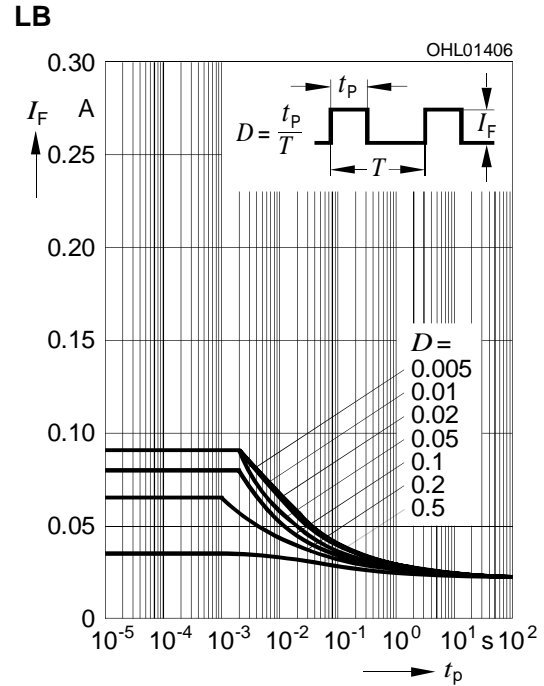

**Zulässige Impulsbelastbarkeit  $I_F = f(t_p)$**   
**Permissible Pulse Handling Capability**  
 Duty cycle  $D = \text{parameter}$ ,  $T_A = 25\text{ °C}$

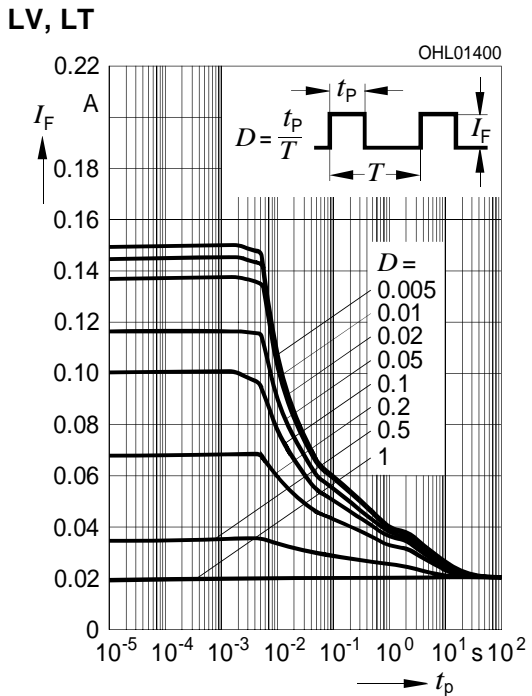

**Zulässige Impulsbelastbarkeit  $I_F = f(t_p)$**   
**Permissible Pulse Handling Capability**  
 Duty cycle  $D = \text{parameter}$ ,  $T_A = 85\text{ °C}$

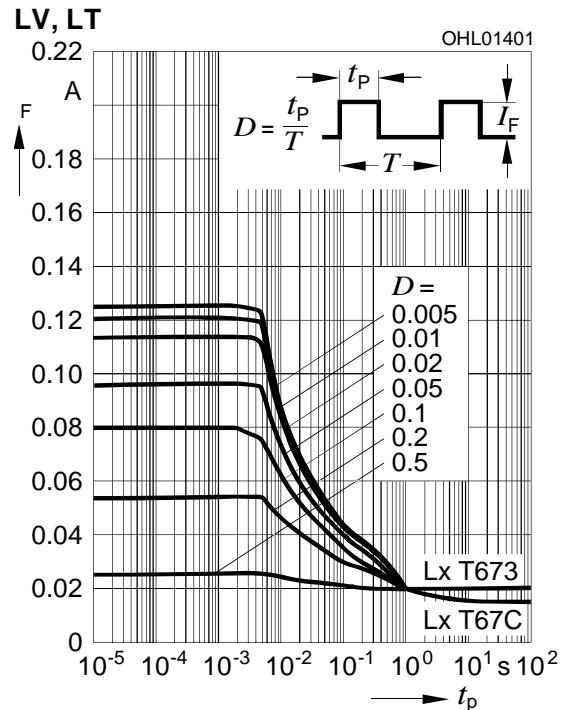

**Maßzeichnung**  
**Package Outlines**

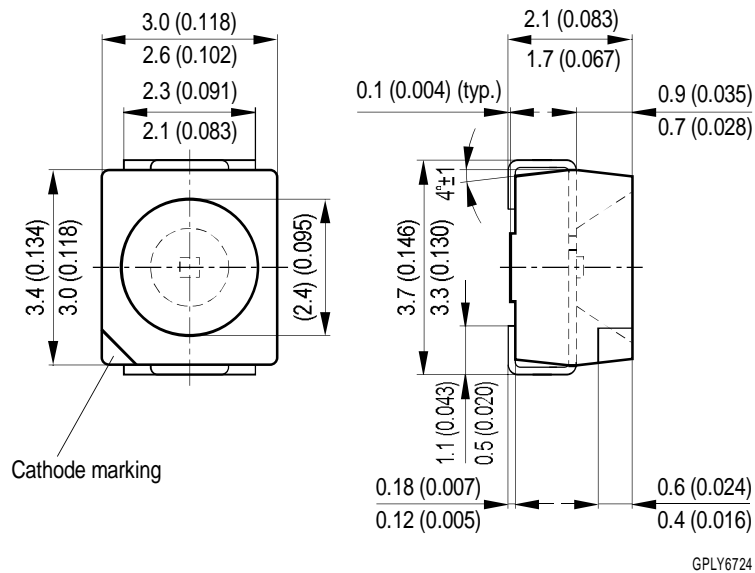

Maße werden wie folgt angegeben: mm (inch) / Dimensions are specified as follows: mm (inch).

**Kathodenkennung:** abgeschrägte Ecke  
**Cathode mark:** bevelled edge  
**Gewicht / Approx. weight:** 40 mg

**Lötbedingungen** Vorbehandlung nach JEDEC Level 2  
**Soldering Conditions** Preconditioning acc. to JEDEC Level 2

**IR-Reflow Lötprofil** (nach IPC 9501)  
**IR Reflow Soldering Profile** (acc. to IPC 9501)

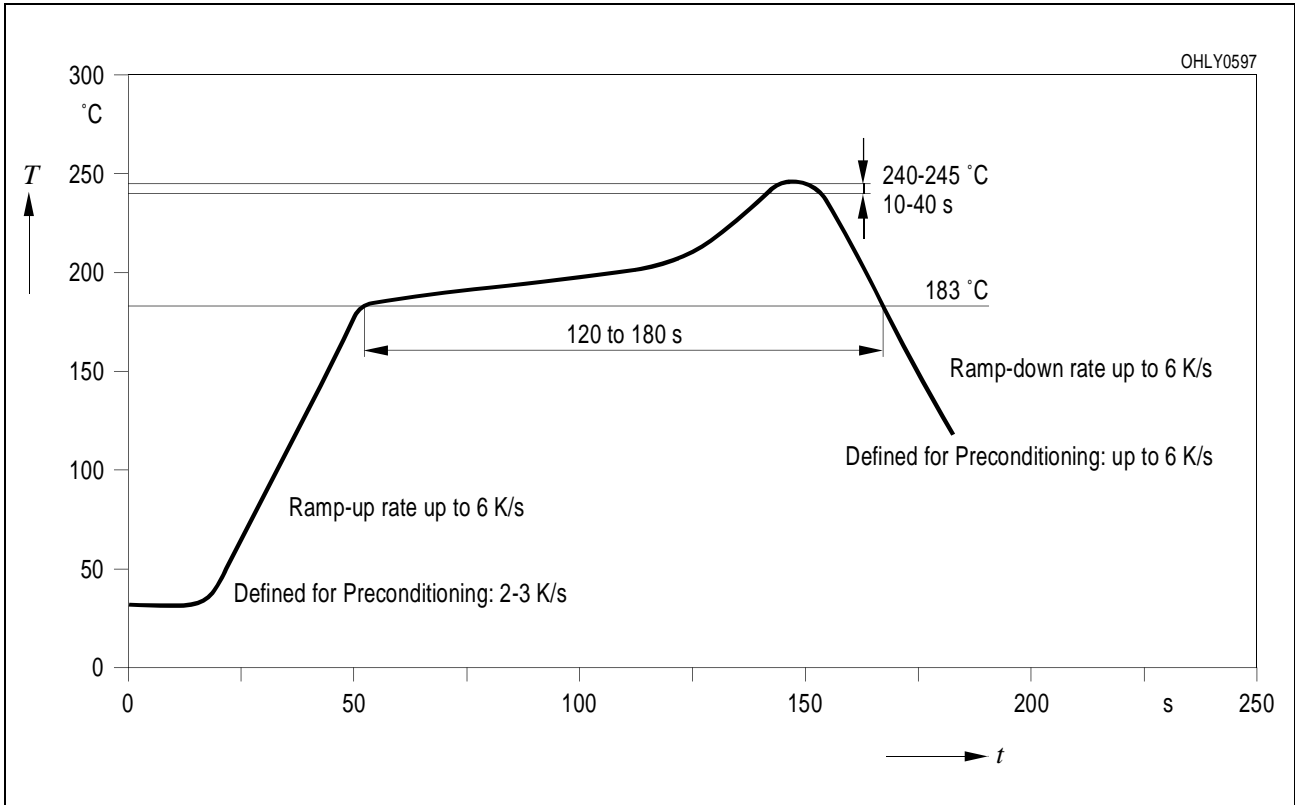

**Wellenlöten (TTW)** (nach CECC 00802)  
**TTW Soldering** (acc. to CECC 00802)

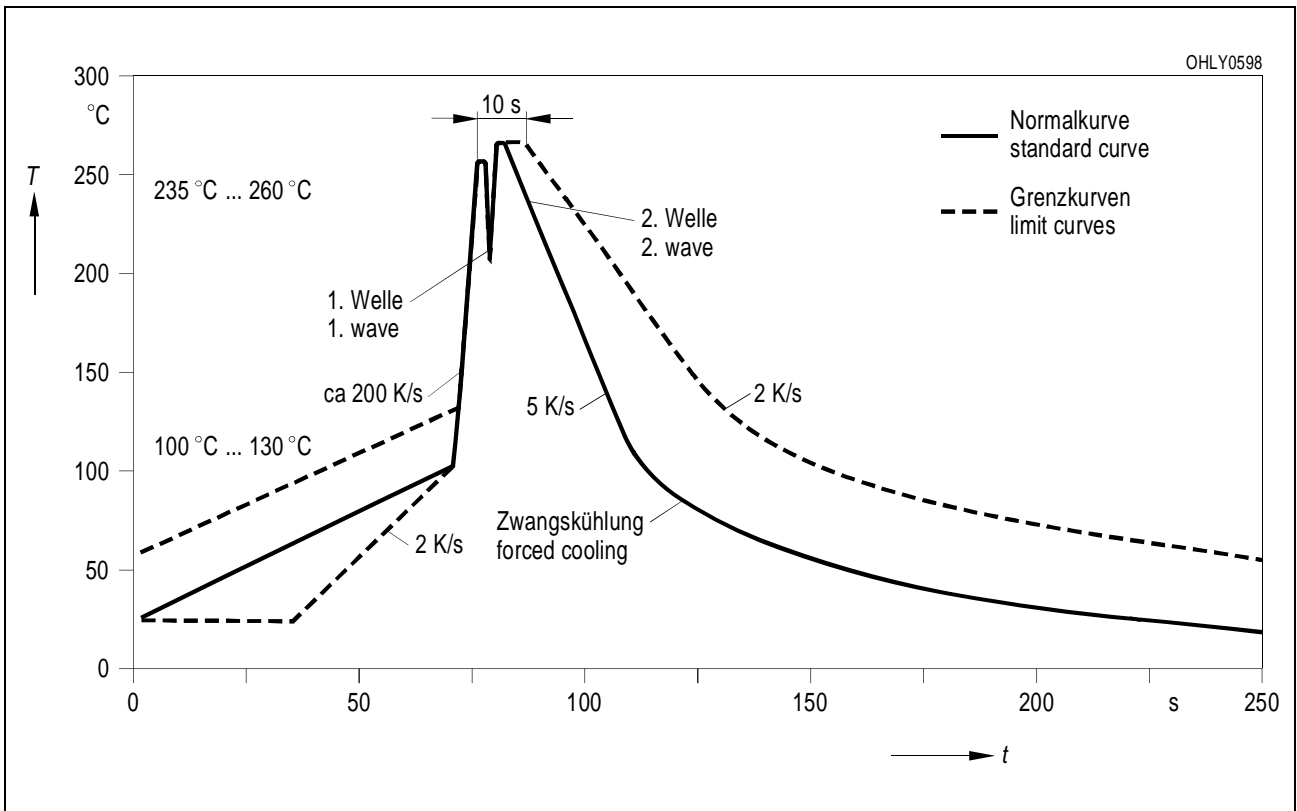

**Empfohlenes Lötpadding** IR Reflow Lötten / Wellenlötten (TTW)  
**Recommended Solder Pad** IR Reflow Soldering / TTW Soldering

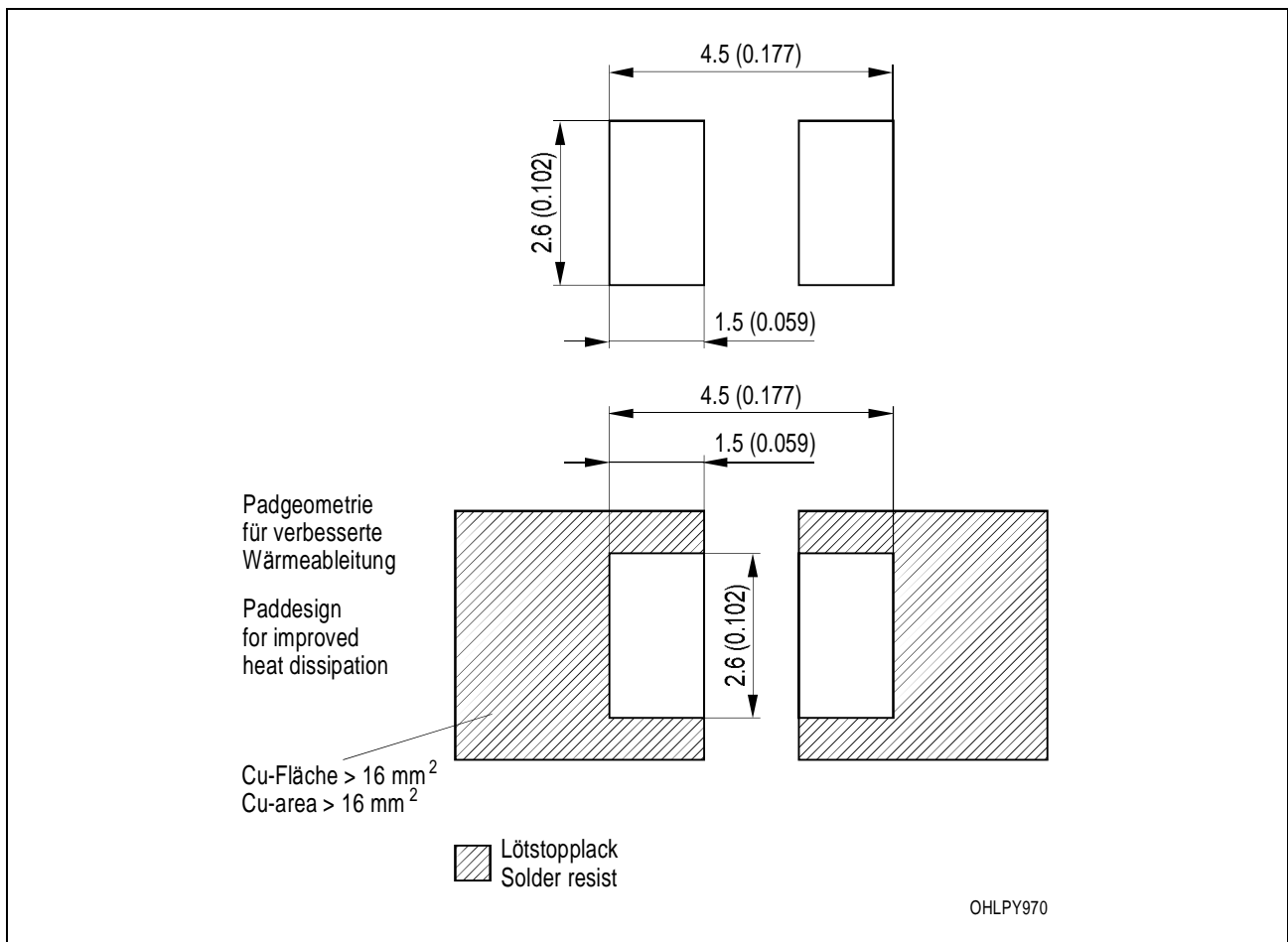

Maße werden wie folgt angegeben: mm (inch) / Dimensions are specified as follows: mm (inch).

**Gurtung / Polarität und Lage**

Verpackungseinheit 2000/Rolle,  $\varnothing$ 180 mm  
oder 8000/Rolle,  $\varnothing$ 330 mm

**Method of Taping / Polarity and Orientation**

Packing unit 2000/reel,  $\varnothing$ 180 mm  
or 8000/reel,  $\varnothing$ 330 mm

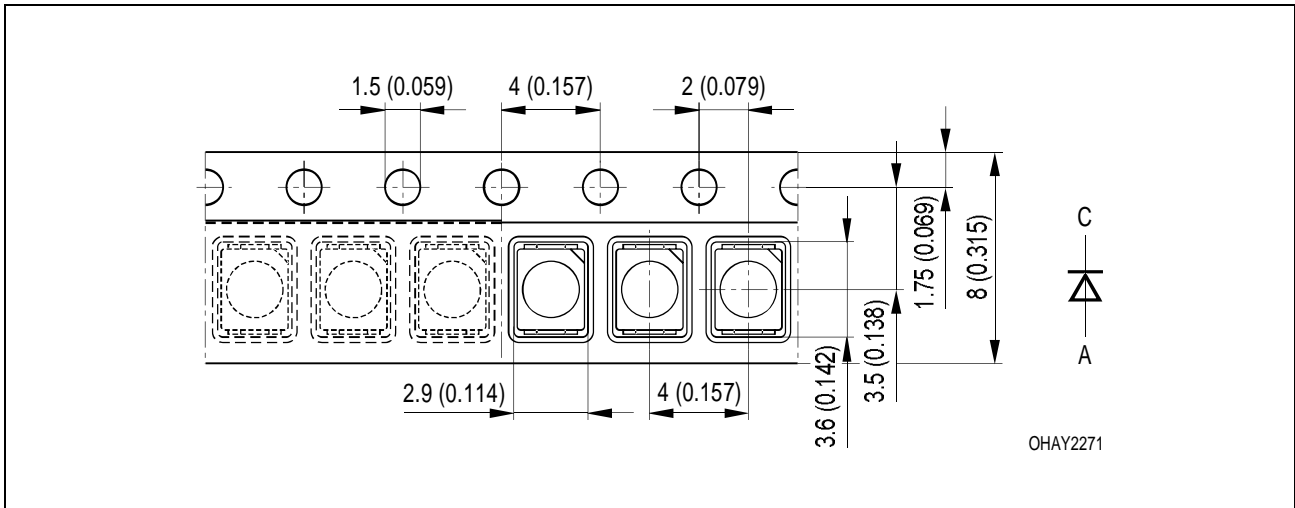

Maße werden wie folgt angegeben: mm (inch) / Dimensions are specified as follows: mm (inch).

---

**Revision History: 2001-06-26**

Previous Version: 2001-02-21

Page	Subjects (major changes since last revision)
1	ESD-Festigkeit, ESD-withstand voltage

**Published by OSRAM Opto Semiconductors GmbH & Co. OHG**  
**Wernerwerkstrasse 2, D-93049 Regensburg**  
**© All Rights Reserved.**

**Attention please!**

The information describes the type of component and shall not be considered as assured characteristics. Terms of delivery and rights to change design reserved. Due to technical requirements components may contain dangerous substances. For information on the types in question please contact our Sales Organization.

**Packing**

Please use the recycling operators known to you. We can also help you – get in touch with your nearest sales office. By agreement we will take packing material back, if it is sorted. You must bear the costs of transport. For packing material that is returned to us unsorted or which we are not obliged to accept, we shall have to invoice you for any costs incurred.

**Components used in life-support devices or systems must be expressly authorized for such purpose!** Critical components <sup>1</sup> may only be used in life-support devices or systems <sup>2</sup> with the express written approval of OSRAM OS.

<sup>1</sup> A critical component is a component used in a life-support device or system whose failure can reasonably be expected to cause the failure of that life-support device or system, or to affect its safety or the effectiveness of that device or system.

<sup>2</sup> Life support devices or systems are intended (a) to be implanted in the human body, or (b) to support and/or maintain and sustain human life. If they fail, it is reasonable to assume that the health of the user may be endangered.